

Hydraulic Pumps Mobile & Industrial T6*R

Denison Vane Technology, fixed displacement

aerospace
climate control
electromechanical
filtration
fluid & gas handling
hydraulics
pneumatics
process control
sealing & shielding



ENGINEERING YOUR SUCCESS.

Model No. **T6ER - 066 - 1 R 00 - A 1 0 - A 1 ..**

Series

Cam ring

(Delivery at 0 bar & 1500 r.p.m.)

042 = 198,5 l/min 062 = 295,0 l/min

045 = 213,6 l/min 066 = 319,9 l/min

050 = 237,7 l/min 072 = 340,6 l/min

052 = 247,2 l/min

Type of shaft

1 = keyed (SAE CC)

3 = splined (SAE C)

4 = splined (SAE CC)

Direct. of rotation (view on shaft end)

R = clockwise

L = counter-clockwise

Porting combination

Modification

Seal class

1 = S1 (for mineral oil)

4 = S4 (for the resistant fluids)

5 = S5 (for mineral oil and fire resistant fluids)

Design letter

Porting adaptor

Coupling

1 = SAE A

2 = SAE B

3 = SAE BB

4 = SAE C

5 = SAE J498b

16/32 - 11 teeth

Adaptor

0 = None

A = SAE A

B = SAE B

C = SAE C

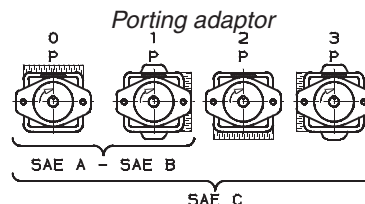
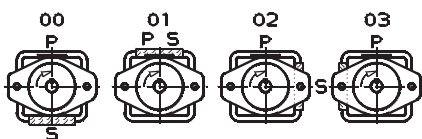

INTERNAL LEAKAGE (TYPICAL)

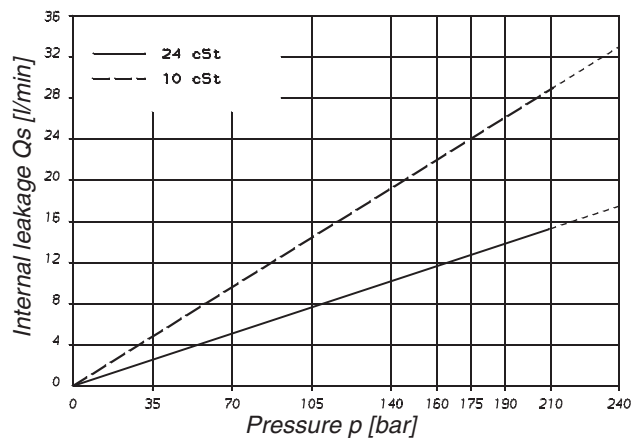

**NOISE LEVEL (TYPICAL)
T6ER - 050**

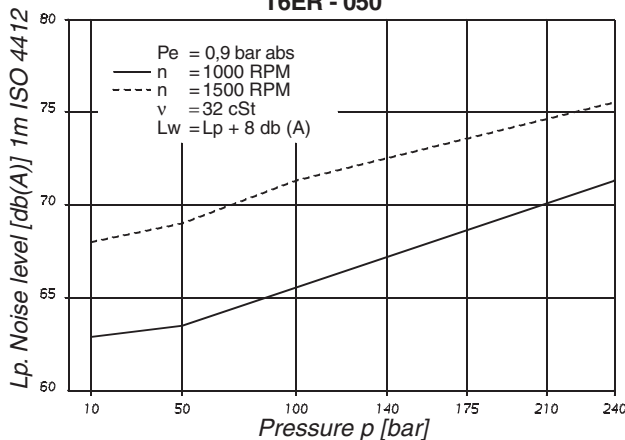

POWER LOSS HYDROMECHANICAL (TYPICAL)

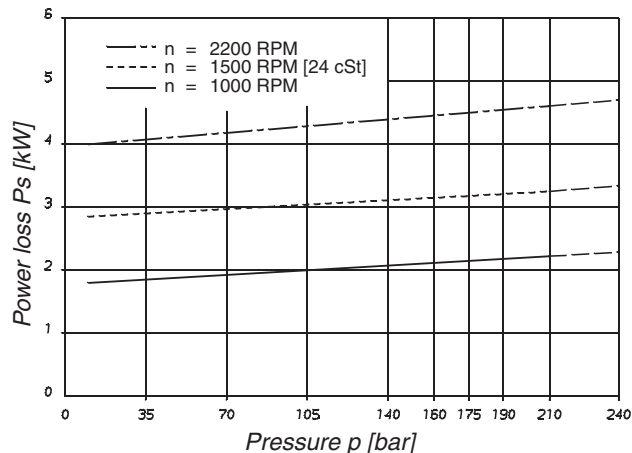

PERMISSIBLE RADIAL LOAD

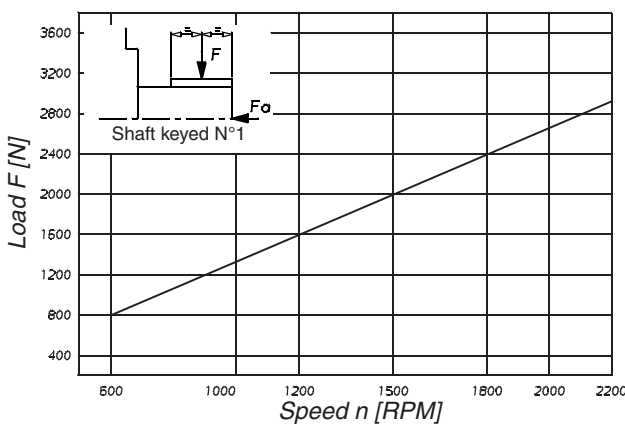

Maximum permissible axial load $F_a = 2000$ N

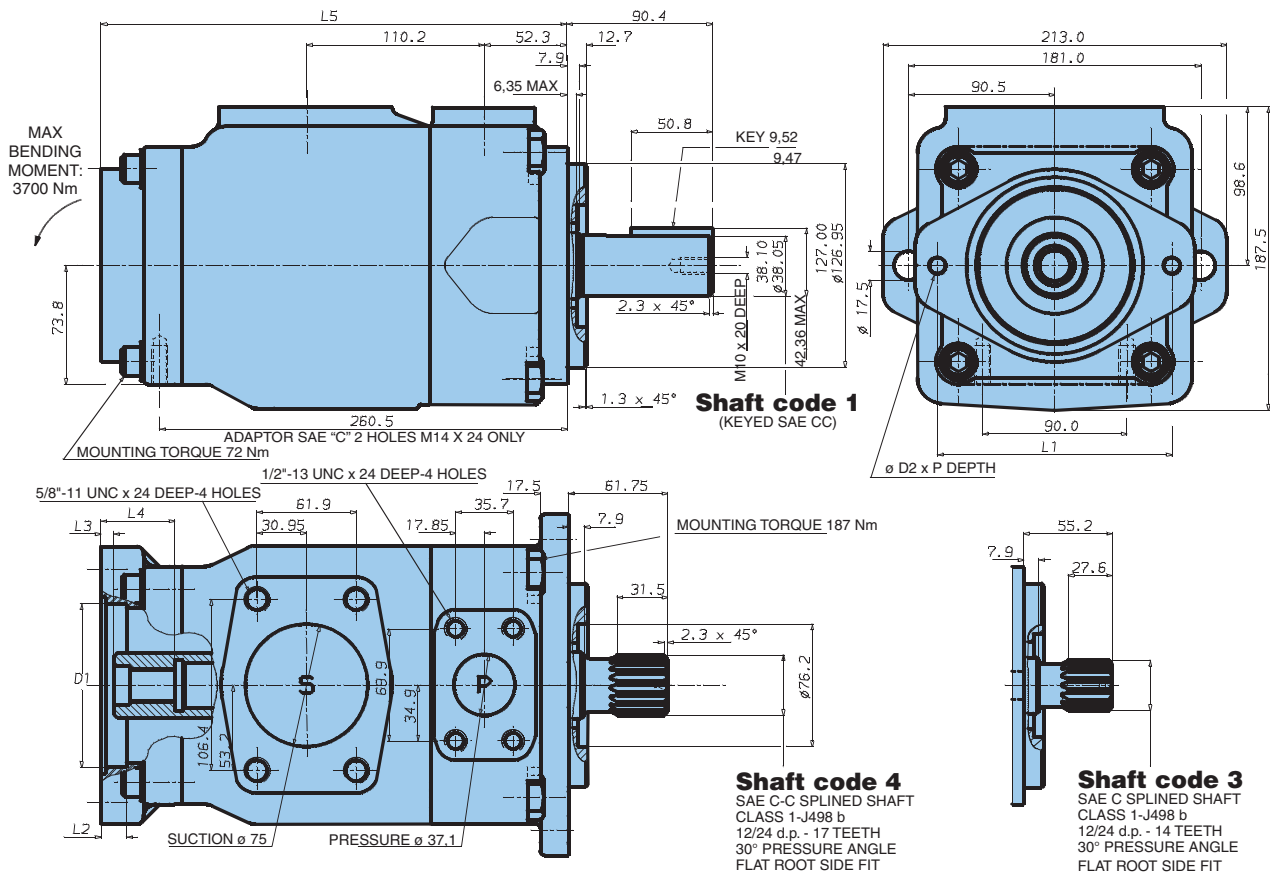

Weight 42.5 kg

Adaptor	D1	D2	P	L1	L2	L3	L4	L5
SAE A	82,65/82,60	M10	24	106,4	11,0	8,0	32,0	272,0
SAE B	101,70/101,65	M12	28	146,0	16,0	8,0	46,0	286,0
SAE C	127,10/127,05	M16	-	181,0	16,0	8,0	56,0	296,0

Adaptor	SAE A			SAE B		SAE C
Coupling drive	SAE A	SAE 11 teeth	SAE B	SAE B	SAE BB	SAE C
Number of teeth	9	11	13	13	15	14
Pitch	16/32	16/32	16/32	16/32	16/32	12/24
Pressure angle	30°	30°	30°	30°	30°	30°
Major dia. (min)	15,875	19,05	22,225	22,225	25,400	31,750
Minor dia. (min)	12,700	16,017	19,134	19,134	22,268	27,589

Shaft torque limits [ml/rev x bar]			
Shaft	Vi x p max.	Coupling drive	Vi x p max.
1	80560	SAE A	11000
2	61200	SAE B	20600
4	120210	SAE BB	32670
		SAE C	66480
		SAE - 11 teeth	15850

OPERATING CHARACTERISTICS - TYPICAL [24 cSt]

Series	Volumetric Displacement Vi	Flow Q [l/min] & n = 1500 RPM			Input power P [kW] & n = 1500 RPM		
		p = 0 bar	p = 140 bar	p = 240 bar	p = 7 bar	p = 140 bar	p = 240 bar
042	132,3 ml/rev	198,5	188,5	181,3	5,2	49,4	82,6
045	142,4 ml/rev	213,6	203,6	196,5	5,4	52,9	88,7
050	158,5 ml/rev	237,7	227,7	220,6	5,7	58,5	98,3
052	164,8 ml/rev	247,2	237,2	230,1	5,8	60,8	102,1
062	196,7 ml/rev	295,0	285,0	277,7	6,4	71,9	121,3
066	213,3 ml/rev	319,9	309,9	302,8	6,7	77,7	131,2
072	227,1 ml/rev	340,6	330,6	323,5	6,9	82,6	139,5

Port connection can be furnished with metric threads.

Parker Worldwide

AE – UAE, Dubai
Tel: +971 4 8127100
parker.me@parker.com

AR – Argentina, Buenos Aires
Tel: +54 3327 44 4129

AT – Austria, Wiener Neustadt
Tel: +43 (0)2622 23501-0
parker.austria@parker.com

AT – Eastern Europe, Wiener Neustadt
Tel: +43 (0)2622 23501 900
parker.easteurope@parker.com

AU – Australia, Castle Hill
Tel: +61 (0)2-9634 7777

AZ – Azerbaijan, Baku
Tel: +994 50 2233 458
parker.azerbaijan@parker.com

BE/LU – Belgium, Nivelles
Tel: +32 (0)67 280 900
parker.belgium@parker.com

BR – Brazil, Cachoeirinha RS
Tel: +55 51 3470 9144

BY – Belarus, Minsk
Tel: +375 17 209 9399
parker.belarus@parker.com

CA – Canada, Milton, Ontario
Tel: +1 905 693 3000

CH – Switzerland, Etoy
Tel: +41 (0) 21 821 02 30
parker.switzerland@parker.com

CL – Chile, Santiago
Tel: +56 2 623 1216

CN – China, Shanghai
Tel: +86 21 2899 5000

CZ – Czech Republic, Klecany
Tel: +420 284 083 111
parker.czechrepublic@parker.com

DE – Germany, Kaarst
Tel: +49 (0)2131 4016 0
parker.germany@parker.com

DK – Denmark, Ballerup
Tel: +45 43 56 04 00
parker.denmark@parker.com

ES – Spain, Madrid
Tel: +34 902 330 001
parker.spain@parker.com

FI – Finland, Vantaa
Tel: +358 (0)20 753 2500
parker.finland@parker.com

FR – France, Contamine s/Arve
Tel: +33 (0)4 50 25 80 25
parker.france@parker.com

GR – Greece, Athens
Tel: +30 210 933 6450
parker.greece@parker.com

HK – Hong Kong
Tel: +852 2428 8008

HU – Hungary, Budapest
Tel: +36 1 220 4155
parker.hungary@parker.com

IE – Ireland, Dublin
Tel: +353 (0)1 466 6370
parker.ireland@parker.com

IN – India, Mumbai
Tel: +91 22 6513 7081-85

IT – Italy, Corsico (MI)
Tel: +39 02 45 19 21
parker.italy@parker.com

JP – Japan, Fujisawa
Tel: +(81) 4 6635 3050

KR – South Korea, Seoul
Tel: +82 2 559 0400

KZ – Kazakhstan, Almaty
Tel: +7 7272 505 800
parker.easteurope@parker.com

LV – Latvia, Riga
Tel: +371 6 745 2601
parker.latvia@parker.com

MX – Mexico, Apodaca
Tel: +52 81 8156 6000

MY – Malaysia, Shah Alam
Tel: +60 3 7849 0800

NL – The Netherlands, Oldenzaal
Tel: +31 (0)541 585 000
parker.nl@parker.com

NO – Norway, Ski
Tel: +47 64 91 10 00
parker.norway@parker.com

NZ – New Zealand, Mt Wellington
Tel: +64 9 574 1744

PL – Poland, Warsaw
Tel: +48 (0)22 573 24 00
parker.poland@parker.com

PT – Portugal, Leca da Palmeira
Tel: +351 22 999 7360
parker.portugal@parker.com

RO – Romania, Bucharest
Tel: +40 21 252 1382
parker.romania@parker.com

RU – Russia, Moscow
Tel: +7 495 645-2156
parker.russia@parker.com

SE – Sweden, Spånga
Tel: +46 (0)8 59 79 50 00
parker.sweden@parker.com

SG – Singapore
Tel: +65 6887 6300

SK – Slovakia, Banská Bystrica
Tel: +421 484 162 252
parker.slovakia@parker.com

SL – Slovenia, Novo Mesto
Tel: +386 7 337 6650
parker.slovenia@parker.com

TH – Thailand, Bangkok
Tel: +662 717 8140

TR – Turkey, Istanbul
Tel: +90 216 4997081
parker.turkey@parker.com

TW – Taiwan, Taipei
Tel: +886 2 2298 8987

UA – Ukraine, Kiev
Tel: +380 44 494 2731
parker.ukraine@parker.com

UK – United Kingdom, Warwick
Tel: +44 (0)1926 317 878
parker.uk@parker.com

US – USA, Cleveland (industrial)
Tel: +1 216 896 3000

US – USA, Lincolnshire (mobile)
Tel: +1 847 821 1500

VE – Venezuela, Caracas
Tel: +58 212 238 5422

ZA – South Africa, Kempton Park
Tel: +27 (0)11 961 0700
parker.southafrica@parker.com

European Product Information Centre
Free phone: 00 800 27 27 5374
(from AT, BE, CH, CZ, DE, DK, EE, ES, FI, FR, IE, IL, IS, IT, LU, MT, NL, NO, PL, PT, RU, SE, UK, ZA)



Parker Hannifin Ltd.
Tachbrook Park Drive
Tachbrook Park, Warwick CV34 6TU
United Kingdom
Tel.: +44 (0) 1926 317 878
Fax: +44 (0) 1926 317 855
www.parker.com